

Introduction to entanglement theory & Detection of multipartite entanglement close to symmetric Dicke states

G. Tóth^{1,2,3}

Collaboration:

Entanglement th.: G. Vitagliano¹, I. Apellaniz¹, I.L. Egusquiza¹,

Cold gas exp.: B. Lücke⁴, J. Peise⁴, J. Arlt⁴, L. Santos⁴, C. Klempt⁴

¹Theoretical Physics, University of the Basque Country UPV/EHU, Bilbao, Spain

²IKERBASQUE, Basque Foundation for Science, Bilbao, Spain

³Wigner Research Centre for Physics, Budapest, Hungary

⁴Institut für Quantenoptik, Leibniz Universität Hannover, Hannover, Germany



1 Motivation

- Why multipartite entanglement is important?

2 Quantum Entanglement

- Geometry of quantum states
- Linear entanglement witnesses
- Non-linear entanglement witnesses
- Experiments

3 Spin squeezing and entanglement

- Collective measurements
- The original spin-squeezing criterion
- Generalized criteria for $j = \frac{1}{2}$

4 Spin squeezing for Dicke states

- Entanglement detection close to Dicke states
- Detection of multipartite entanglement close to Dicke states
- Our conditions are stronger than the original conditions

Why multipartite entanglement is important?

- Full tomography is not possible, we still have to say something meaningful.
- Claiming “entanglement” is not sufficient for many particles.
- Many experiments are aiming to create entangled states with many atoms.
- Only collective quantities can be measured.

Notation

- Qubit: $|\Psi\rangle = \alpha|0\rangle + \beta|1\rangle$,
- Density matrix: $\rho = \sum_k p_k |\Psi_k\rangle\langle\Psi_k|$,
- Expectation value: $\langle A \rangle = \text{Tr}(\rho A)$.
- Variance: $(\Delta A)^2 = \text{Tr}(\rho A^2) - \text{Tr}(\rho A)^2$.

Definition of Entanglement

A state is **(fully) separable** if it can be written as

$$\sum_k p_k \rho_1^{(k)} \otimes \rho_2^{(k)} \otimes \dots \otimes \rho_N^{(k)}.$$

If a state is not separable then it is **entangled**.

R.F. Werner, Phys. Rev. A 1989

Questions for multipartite entanglement

For many particles, it is not sufficient to say “entangled”/”not entangled”.

We have to have more than these two levels.

A pure state is **k -producible** if it can be written as

$$|\Phi\rangle = |\Phi_1\rangle \otimes |\Phi_2\rangle \otimes |\Phi_3\rangle \otimes |\Phi_4\rangle \dots$$

where $|\Phi_j\rangle$ are states of at most k qubits.

A mixed state is k -producible, if it is a mixture of k -producible pure states.

[e.g., O. Gühne and GT, New J. Phys 2005.]

- If a state is not k -producible, then it is at least **$(k + 1)$ -particle entangled**.

Genuine multipartite entanglement

- N -particle entanglement \equiv genuine multipartite entanglement.

Usefulness of entanglement

- Entangled states are useful for quantum cryptography, for quantum teleportation.
- Entangled states outperform separable ones in very general tasks in quantum metrology.
- Note: Entanglement cannot be obtained from separable states with local operations and classical communications (LOCC). It is a resource.

Entanglement detection

- It is a very hard task to decide whether a quantum state is separable or not.
- Solved for small systems: 2×2 , 2×3 . (Peres-Horodecki condition, 1997.)
- In general, necessary conditions for separability exist. If they are violated, then we know that the state is entangled

Examples

Examples

Two entangled states of four qubits:

$$|GHZ_4\rangle = \frac{1}{\sqrt{2}}(|0000\rangle + |1111\rangle),$$

$$|\Psi_B\rangle = \frac{1}{\sqrt{2}}(|0000\rangle + |0011\rangle) = \frac{1}{\sqrt{2}}|00\rangle \otimes (|00\rangle + |11\rangle).$$

- The first state is genuine multipartite entangled, the second state is biseparable.

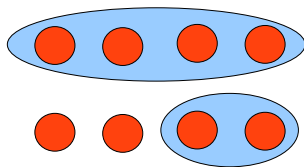

1 Motivation

- Why multipartite entanglement is important?

2 Quantum Entanglement

- Geometry of quantum states
- Linear entanglement witnesses
- Non-linear entanglement witnesses
- Experiments

3 Spin squeezing and entanglement

- Collective measurements
- The original spin-squeezing criterion
- Generalized criteria for $j = \frac{1}{2}$

4 Spin squeezing for Dicke states

- Entanglement detection close to Dicke states
- Detection of multipartite entanglement close to Dicke states
- Our conditions are stronger than the original conditions

Theory of quantum entanglement

- Separable states form a convex set.

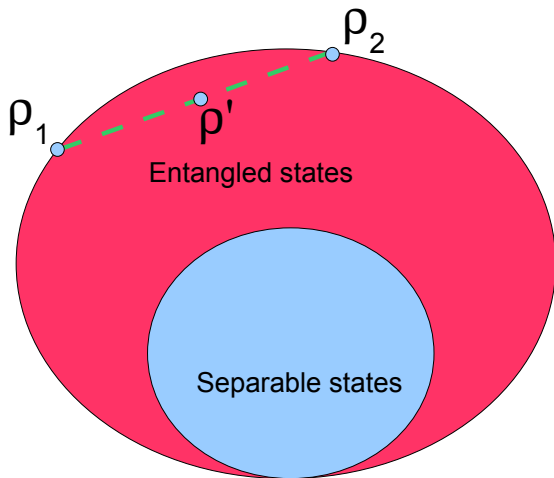

Theory of quantum entanglement II

- A more accurate picture:

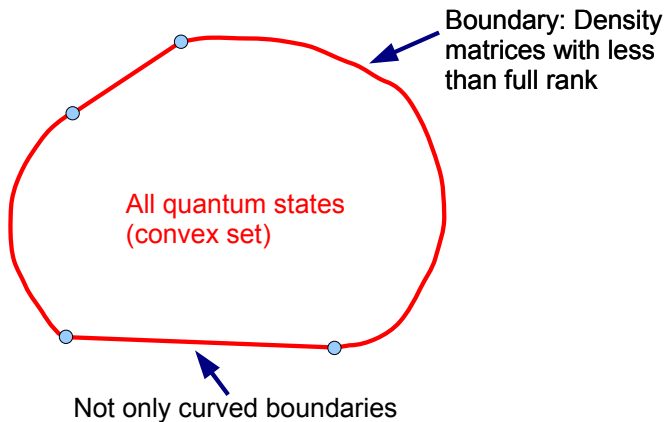

Theory of quantum entanglement III

- Together with the set of separable states:

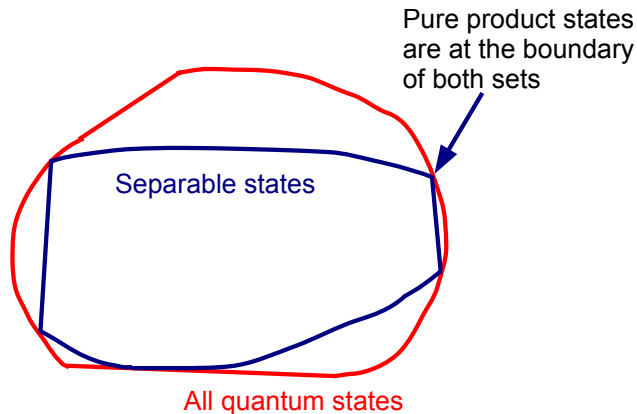

1 Motivation

- Why multipartite entanglement is important?

2 Quantum Entanglement

- Geometry of quantum states
- **Linear entanglement witnesses**
- Non-linear entanglement witnesses
- Experiments

3 Spin squeezing and entanglement

- Collective measurements
- The original spin-squeezing criterion
- Generalized criteria for $j = \frac{1}{2}$

4 Spin squeezing for Dicke states

- Entanglement detection close to Dicke states
- Detection of multipartite entanglement close to Dicke states
- Our conditions are stronger than the original conditions

Witnesses based on correlations

Definition

An **entanglement witness** \mathcal{W} is an operator that is positive on all separable (biseparable) states.

Thus, $\text{Tr}(\mathcal{W}\rho) < 0$ signals entanglement (genuine multipartite entanglement).

[Horodecki 1996; Terhal 2000; Lewenstein, Kraus, Cirac, Horodecki 2002]

There are two main goals when searching for entanglement witnesses:

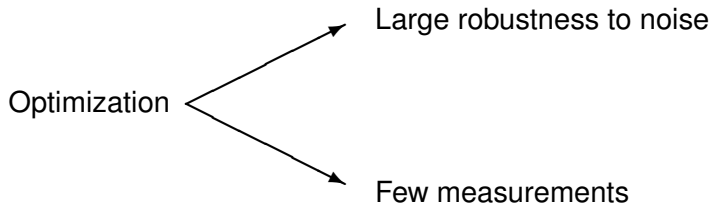

Convex sets for the entanglement witnesses

- Entanglement witnesses in the convex set picture

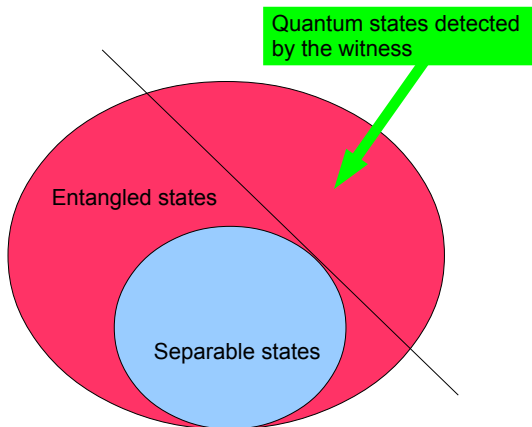

Witnesses based on correlations

Example

Witness with Heisenberg interaction

$$\mathcal{W}_{xyz} = \mathbb{1} \otimes \mathbb{1} + \sigma_x^{(1)} \otimes \sigma_x^{(2)} + \sigma_y^{(1)} \otimes \sigma_y^{(2)} + \sigma_z^{(1)} \otimes \sigma_z^{(2)}.$$

Proof. For product states of the form $|\Psi\rangle = |\Psi_1\rangle \otimes |\Psi_2\rangle$, we have

$$\langle \sigma_x \otimes \sigma_x \rangle + \langle \sigma_y \otimes \sigma_y \rangle + \langle \sigma_z \otimes \sigma_z \rangle = \sum_{l=x,y,z} \langle \sigma_l \rangle_{\Psi_1} \langle \sigma_l \rangle_{\Psi_2} \geq -1.$$

Here, we used the Cauchy-Schwarz inequality. Due to convexity, the inequality is also true for separable states.

The minimum for quantum states is -3 . Such a maximum is obtained for the state

$$\frac{1}{\sqrt{2}} (|01\rangle - |10\rangle).$$

Witnesses based on correlations II

Example

Witness with the Heisenberg chain Hamiltonian interaction

$$H = \sum_{n=1}^{N-1} \sigma_x^{(n)} \otimes \sigma_x^{(n+1)} + \sigma_y^{(n)} \otimes \sigma_y^{(n+1)} + \sigma_z^{(n)} \otimes \sigma_z^{(n+1)}.$$

For product states

$$\langle H \rangle \geq -(N - 1).$$

This is also true for separable states. Any state violating this inequality is entangled.

Witnesses based on correlations III

- This can be used in spin chains. If the energy is lower than the minimal energy of the classical model then the ground state is entangled.

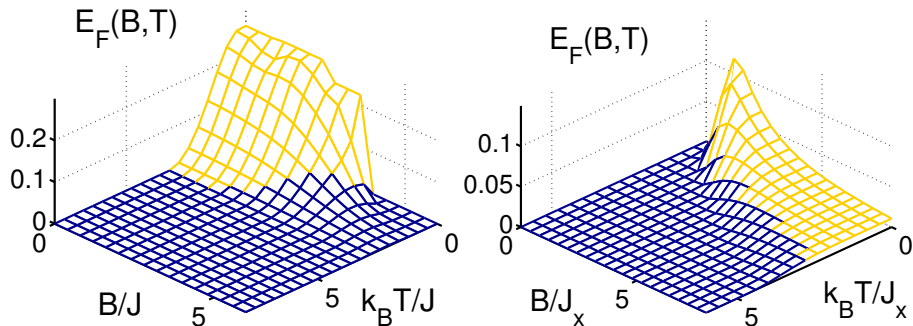

Heisenberg chain in an external field / Ising spin chain in a transverse field. Yellow = detected as entangled.

[G. Tóth, Phys. Rev. A 71, 010301(R) (2005); Ć. Brukner and V. Vedral, e-print quant-ph/0406040; M. R. Dowling, A. C. Doherty, and S. D. Bartlett, Phys. Rev. A 70, 062113 2004.]

Witnesses for multipartite entanglement

- Can be used to obtain qualitative information on the thermal state.

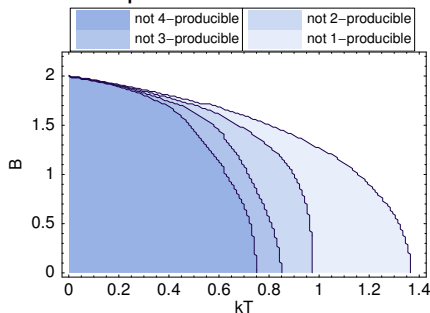

- XX-model in external field at finite temperature.
- not k -producible \equiv at least $(k + 1)$ -particle entanglement

[O. Gühne, G. Tóth, *New J. Phys.* 7, 229 (2005); O. Gühne, G. Tóth, *Phys. Rev. A* 73, 052319 (2006).]

1 Motivation

- Why multipartite entanglement is important?

2 Quantum Entanglement

- Geometry of quantum states
- Linear entanglement witnesses
- Non-linear entanglement witnesses
- Experiments

3 Spin squeezing and entanglement

- Collective measurements
- The original spin-squeezing criterion
- Generalized criteria for $j = \frac{1}{2}$

4 Spin squeezing for Dicke states

- Entanglement detection close to Dicke states
- Detection of multipartite entanglement close to Dicke states
- Our conditions are stronger than the original conditions

Variance-based criteria

For a bipartite system, for both parties

$$(\Delta A_k)^2 + (\Delta B_k)^2 \geq L_k.$$

For product states of the form $|\Psi\rangle = |\Psi_1\rangle \otimes |\Psi_2\rangle$, we have

$$(\Delta(A_1 + A_2))^2 = \langle (A_1 + A_2)^2 \rangle - \langle A_1 + A_2 \rangle^2 = (\Delta A_1)_{\Psi_1}^2 + (\Delta A_2)_{\Psi_2}^2$$

since for product states

$$\langle A_1 A_2 \rangle - \langle A_1 \rangle \langle A_2 \rangle = 0.$$

Hence,

$$(\Delta(A_1 + A_2))^2 + (\Delta(B_1 + B_2))^2 \geq L_1 + L_2.$$

This is also true for separable states due to the convexity of separable states.

[See Gühne, Phys. Rev. Lett. (2004) for an exhaustive study.]

Variance-based criteria II

Example: we have

$$(\Delta x)^2(\Delta p)^2 \geq \frac{1}{4}.$$

Hence,

$$(\Delta x)^2 + (\Delta p)^2 \geq 1.$$

Then, for two-mode separable states

$$(\Delta(x_1 + x_2))^2 + (\Delta(p_1 - p_2))^2 \geq 2.$$

Any state violating this is entangled.

[Generalization: L.M. Duan, G. Giedke, J.I. Cirac, P. Zoller, Phys. Rev. Lett (2000); R. Simon, Phys. Rev. Lett (2000).]

1 Motivation

- Why multipartite entanglement is important?

2 Quantum Entanglement

- Geometry of quantum states
- Linear entanglement witnesses
- Non-linear entanglement witnesses
- Experiments

3 Spin squeezing and entanglement

- Collective measurements
- The original spin-squeezing criterion
- Generalized criteria for $j = \frac{1}{2}$

4 Spin squeezing for Dicke states

- Entanglement detection close to Dicke states
- Detection of multipartite entanglement close to Dicke states
- Our conditions are stronger than the original conditions

Experiment with photons

- A photon can have a horizontal (H) and a vertical (V) polarization.
- H/V can take the role of 0 and 1.
- Problem: photons do not interact with each other.

Photons II

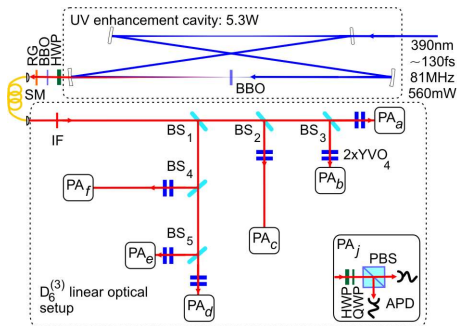

MPQ, Munich. Experiments with 6 photons.

[W. Wieczorek, R. Krischek, N. Kiesel, P. Michelberger, G. Tóth, and H. Weinfurter, Phys. Rev. Lett. 2009.]

$$|D_6^{(3)}\rangle = \frac{1}{\sqrt{20}} (|111000\rangle + |110100\rangle + \dots + |000111\rangle).$$

Photons III

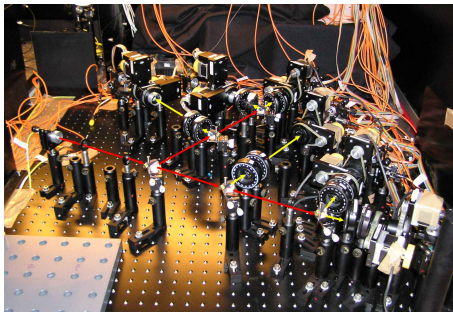

Photons IV

6-qubit Quantum state tomography

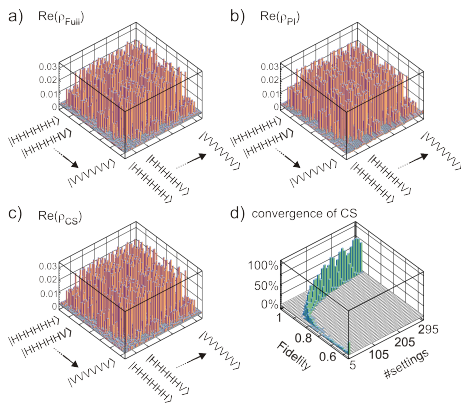

[C. Schwemmer, G. Tóth, A. Niggebaum, T. Moroder, D. Gross, O. Gühne, and H. Weinfurter, Phys. Rev. Lett 113, 040503 (2014).]

Photons V

- Entanglement witness for Detecting genuine multipartite entanglement close to Dicke states

$$\mathcal{W}_D := \frac{3}{5} \mathbb{1} - |D_6^{(3)}\rangle\langle D_6^{(3)}|,$$

where

$$|D_6^{(3)}\rangle = \frac{1}{\sqrt{20}} (|111000\rangle + |110100\rangle + \dots + |000111\rangle).$$

- If we have

$$\langle \mathcal{W}_D \rangle < 0$$

then the state is genuine multipartite entangled.

[G. Tóth, JOSAB 2007.]

1 Motivation

- Why multipartite entanglement is important?

2 Quantum Entanglement

- Geometry of quantum states
- Linear entanglement witnesses
- Non-linear entanglement witnesses
- Experiments

3 Spin squeezing and entanglement

- Collective measurements
- The original spin-squeezing criterion
- Generalized criteria for $j = \frac{1}{2}$

4 Spin squeezing for Dicke states

- Entanglement detection close to Dicke states
- Detection of multipartite entanglement close to Dicke states
- Our conditions are stronger than the original conditions

Many-particle systems for $j=1/2$

- For spin- $\frac{1}{2}$ particles, we can measure the **collective angular momentum operators**:

$$J_l := \frac{1}{2} \sum_{k=1}^N \sigma_l^{(k)},$$

where $l = x, y, z$ and $\sigma_l^{(k)}$ a Pauli spin matrices.

- We can also measure the **variances**

$$(\Delta J_l)^2 := \langle J_l^2 \rangle - \langle J_l \rangle^2.$$

1 Motivation

- Why multipartite entanglement is important?

2 Quantum Entanglement

- Geometry of quantum states
- Linear entanglement witnesses
- Non-linear entanglement witnesses
- Experiments

3 Spin squeezing and entanglement

- Collective measurements
- The original spin-squeezing criterion
- Generalized criteria for $j = \frac{1}{2}$

4 Spin squeezing for Dicke states

- Entanglement detection close to Dicke states
- Detection of multipartite entanglement close to Dicke states
- Our conditions are stronger than the original conditions

The standard spin-squeezing criterion

The **spin squeezing parameter** is defined as

$$\xi_s^2 = N \frac{(\Delta J_z)^2}{\langle J_x \rangle^2 + \langle J_y \rangle^2}.$$

[A. Sørensen, L.M. Duan, J.I. Cirac, P. Zoller, Nature 409, 63 (2001).]

- If $\xi_s^2 < 1$ then the state is entangled.
- States detected are like this:

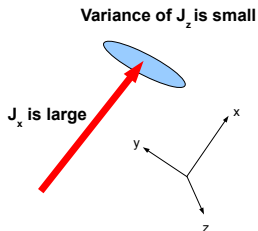

Multipartite entanglement in spin squeezing

- We consider pure k -producible states of the form

$$|\Psi\rangle = \otimes_{n=1}^M |\psi^{(n)}\rangle,$$

where $|\psi^{(n)}\rangle$ is the state of at most k qubits.

The **spin-squeezing criterion for k -producible states** is

$$(\Delta J_z)^2 \geq J_{\max} F_{\frac{k}{2}} \left(\frac{\sqrt{\langle J_x \rangle^2 + \langle J_y \rangle^2}}{J_{\max}} \right),$$

where $J_{\max} = \frac{N}{2}$ and we use the definition

$$F_j(X) := \frac{1}{j} \min_{\frac{\langle j_x \rangle}{j} = X} (\Delta j_z)^2.$$

[Sørensen and Mølmer, Phys. Rev. Lett. 86, 4431 (2001);
experimental test: C. Gross *et al.*, Nature 464, 1165 (2010).]

1 Motivation

- Why multipartite entanglement is important?

2 Quantum Entanglement

- Geometry of quantum states
- Linear entanglement witnesses
- Non-linear entanglement witnesses
- Experiments

3 Spin squeezing and entanglement

- Collective measurements
- The original spin-squeezing criterion
- Generalized criteria for $j = \frac{1}{2}$

4 Spin squeezing for Dicke states

- Entanglement detection close to Dicke states
- Detection of multipartite entanglement close to Dicke states
- Our conditions are stronger than the original conditions

Generalized spin squeezing criteria for $j = \frac{1}{2}$

- Let us assume that for a system we know only

$$\vec{J} := (\langle J_x \rangle, \langle J_y \rangle, \langle J_z \rangle),$$

$$\vec{K} := (\langle J_x^2 \rangle, \langle J_y^2 \rangle, \langle J_z^2 \rangle).$$

- Then any state violating the following inequalities is entangled:

$$\langle J_x^2 \rangle + \langle J_y^2 \rangle + \langle J_z^2 \rangle \leq \frac{N(N+2)}{4},$$

$$(\Delta J_x)^2 + (\Delta J_y)^2 + (\Delta J_z)^2 \geq \frac{N}{2},$$

$$\langle J_k^2 \rangle + \langle J_l^2 \rangle \leq (N-1)(\Delta J_m)^2 + \frac{N}{2},$$

$$(N-1) [(\Delta J_k)^2 + (\Delta J_l)^2] \geq \langle J_m^2 \rangle + \frac{N(N-2)}{4},$$

where k, l, m take all the possible permutations of x, y, z .

Generalized spin squeezing criteria for $j = \frac{1}{2} \mathbb{I}$

- Separable states are in the polytope

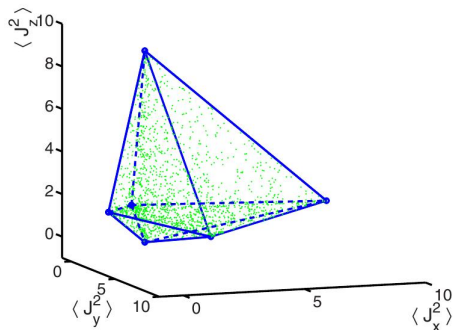

- We set $\langle J_l \rangle = 0$ for $l = x, y, z$.

Spin squeezing criteria – Two-particle correlations

All quantities needed can be obtained with two-particle correlations

$$\langle J_I \rangle = N \langle j_I \otimes \mathbb{1} \rangle_{\rho_{p2}}; \quad \langle J_I^2 \rangle = \frac{N}{4} + N(N-1) \langle j_I \otimes j_I \rangle_{\rho_{p2}}.$$

- Here, the average 2-particle density matrix is defined as

$$\rho_{2p} = \frac{1}{N(N-1)} \sum_{n \neq m} \rho_{mn}.$$

- Still, we can detect states with a separable ρ_{p2} .
- Still, as we will see, we can even detect multipartite entanglement!

1 Motivation

- Why multipartite entanglement is important?

2 Quantum Entanglement

- Geometry of quantum states
- Linear entanglement witnesses
- Non-linear entanglement witnesses
- Experiments

3 Spin squeezing and entanglement

- Collective measurements
- The original spin-squeezing criterion
- Generalized criteria for $j = \frac{1}{2}$

4 Spin squeezing for Dicke states

- Entanglement detection close to Dicke states
- Detection of multipartite entanglement close to Dicke states
- Our conditions are stronger than the original conditions

Dicke states

- Symmetric Dicke states with $\langle J_z \rangle = 0$ (simply “Dicke states” in the following) are defined as

$$|D_N\rangle = \binom{N}{\frac{N}{2}}^{-\frac{1}{2}} \sum_k \mathcal{P}_k \left(|0\rangle^{\otimes \frac{N}{2}} \otimes |1\rangle^{\otimes \frac{N}{2}} \right).$$

- E.g., for four qubits they look like

$$|D_4\rangle = \frac{1}{\sqrt{6}} (|0011\rangle + |0101\rangle + |1001\rangle + |0110\rangle + |1010\rangle + |1100\rangle).$$

[photons: Kiesel *et al.*, Phys. Rev. Lett. 2007; Prevedel *et al.*, Phys. Rev. Lett 2007; Wieczorek *et al.*, Phys. Rev. Lett. 2009]

[cold atoms: Lücke *et al.*, Science 2011; Hamley *et al.*, Science 2011]

Dicke states are useful because they ...

- ... possess strong multipartite entanglement, like GHZ states.

[GT, JOSAB 2007.]

- ... are optimal for quantum metrology, similarly to GHZ states.

[Hyllus *et al.*, PRA 2012; Lücke *et al.*, Science 2011.]

[GT, PRA 2012;

GT and Apellaniz, J. Phys. A, special issue for “50 year of Bell’s theorem”, 2014.]

- ... are macroscopically entangled, like GHZ states.

[Fröwis, Dür, PRL 2011]

Spin Squeezing Inequality for Dicke states

- Let us rewrite the third inequality

$$\langle J_k^2 \rangle + \langle J_l^2 \rangle - \frac{N}{2} \leq (N-1)(\Delta J_m)^2.$$

- It detects states close to Dicke states since

$$\langle J_x^2 + J_y^2 \rangle = \frac{N}{2} \left(\frac{N}{2} + 1 \right) = \max.,$$
$$\langle J_z^2 \rangle = 0.$$

1 Motivation

- Why multipartite entanglement is important?

2 Quantum Entanglement

- Geometry of quantum states
- Linear entanglement witnesses
- Non-linear entanglement witnesses
- Experiments

3 Spin squeezing and entanglement

- Collective measurements
- The original spin-squeezing criterion
- Generalized criteria for $j = \frac{1}{2}$

4 Spin squeezing for Dicke states

- Entanglement detection close to Dicke states
- Detection of multipartite entanglement close to Dicke states
- Our conditions are stronger than the original conditions

Multipartite entanglement around Dicke states

- Measure the same quantities as before

$$(\Delta J_z)^2$$

and

$$\langle J_x^2 + J_y^2 \rangle.$$

- In contrast, for the original spin-squeezing criterion we measured $(\Delta J_z)^2$ and $\langle J_x \rangle^2 + \langle J_y \rangle^2$.
- Pioneering work: linear condition of Luming Duan, Phys. Rev. Lett. (2011). See also Zhang, Duan, arxiv (2014).

Multipartite entanglement - Our condition

- Sørensen-Mølmer condition for k -producible states

$$(\Delta J_z)^2 \geq J_{\max} F_{\frac{k}{2}} \left(\frac{\sqrt{\langle J_x \rangle^2 + \langle J_y \rangle^2}}{J_{\max}} \right).$$

- Combine it with

$$\langle J_x^2 + J_y^2 \rangle \leq J_{\max} \left(\frac{k}{2} + 1 \right) + \langle J_x \rangle^2 + \langle J_y \rangle^2,$$

which is true for pure k -producible states. (Remember, $J_{\max} = \frac{N}{2}$.)

Condition for **entanglement detection around Dicke states**

$$(\Delta J_z)^2 \geq J_{\max} F_{\frac{k}{2}} \left(\frac{\sqrt{\langle J_x^2 + J_y^2 \rangle - J_{\max} \left(\frac{k}{2} + 1 \right)}}{J_{\max}} \right).$$

Due to convexity properties of the expression, this is also valid to mixed separable states.

Concrete example

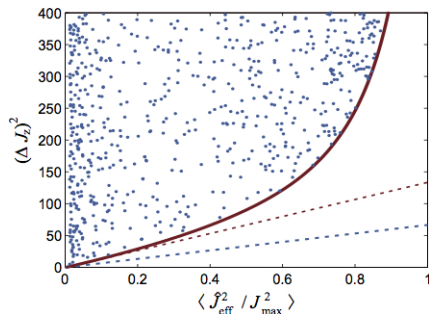

- $N = 8000$ particles, and $J_{\text{eff}} = J_x^2 + J_y^2$.
- **Red curve:** boundary for 28-particle entanglement.
- **Blue dashed line:** linear condition given in [L.-M. Duan, Phys. Rev. Lett. 107, 180502 (2011).]
- **Red dashed line:** tangent of our curve.

1 Motivation

- Why multipartite entanglement is important?

2 Quantum Entanglement

- Geometry of quantum states
- Linear entanglement witnesses
- Non-linear entanglement witnesses
- Experiments

3 Spin squeezing and entanglement

- Collective measurements
- The original spin-squeezing criterion
- Generalized criteria for $j = \frac{1}{2}$

4 Spin squeezing for Dicke states

- Entanglement detection close to Dicke states
- Detection of multipartite entanglement close to Dicke states
- Our conditions are stronger than the original conditions

Our condition is stronger

- Consider spin squeezed states as ground states of

$$H(\Lambda) = J_z^2 - \Lambda J_x.$$

For $\Lambda = \infty$, the ground state is fully polarized. For $\Lambda = 0$, it is the symmetric Dicke state.

- Our condition vs. original condition for $N=4000$ and $p=0.05$

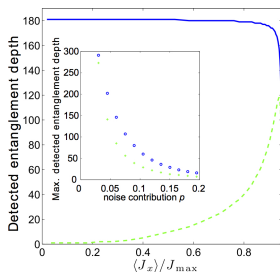

Experimental results

- Bose-Einstein condensate, 8000 particles. 28-particle entanglement is detected.

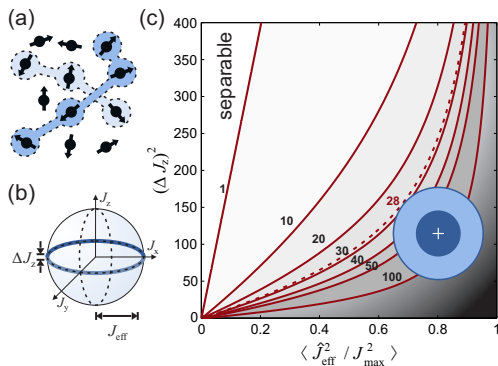

[Lücke *et al.*, Phys. Rev. Lett. 112, 155304 (2014).]

Project participants

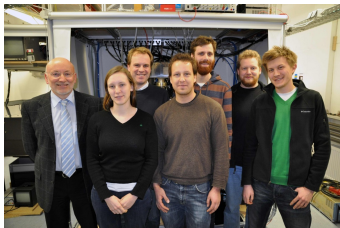

C. Klempt, B. Lücke, J. Mahnke
W. Ertmer, I. Geisel, J. Peise, S. Coleman



L. Santos

Hannover



G. Vitagliano

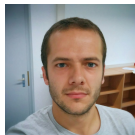

I. Apellaniz



I.L. Egusquiza

Bilbao

Summary

- Detection of multipartite entanglement close to Dicke states, by measuring collective quantities only.
- The condition detects all entangled states that can be detected based on the measured quantities (i.e., it is optimal).

Vitagliano, Apellaniz, Egusquiza, GT, PRA (2014).

Lücke, Peise, Vitagliano, Arlt, Santos, GT, Klempt,
PRL 112, 155304 (2014)

(synopsis at physics.aps.org, Revista Española de Física).

THANK YOU FOR YOUR ATTENTION!
FOR TRANSPARENCIES, PLEASE SEE www.gtoth.eu.

